

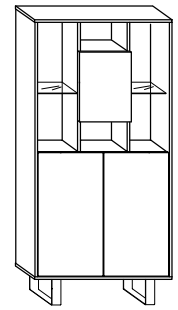

KIN-05 REGAŁ A

→ 80 ↑ 165 ↘ 36



x 10



(a)

x 8



(b)

x 20

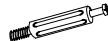

(c)

x 20



(d)

x 2



(e)

x 4

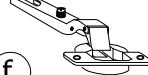

(f)

x 6

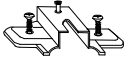

(g)

x 12



(h)

x 3



(j)

x 26

(3,5x16)



(l)

x 70

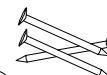

(m)

x 1



(n)

x 2

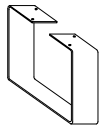

(i)

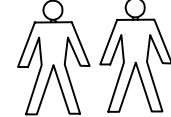
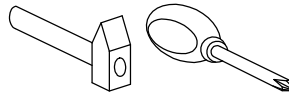

40 min

**1** - FAZY MONTAŻU**A** - OZNACZENIE ELEMENTÓW**a** - OZNACZENIE AKCESORIÓW**1**

(a)

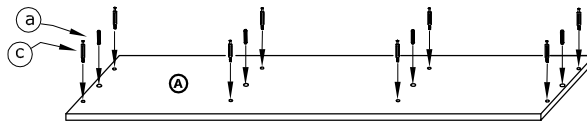

(c)

**2**

(a)



(c)



(g)

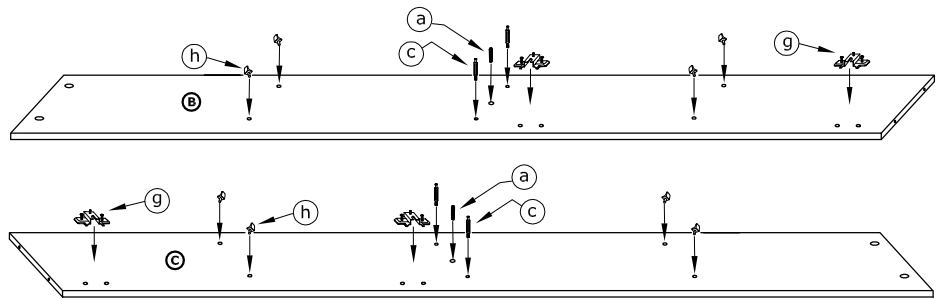

(h)

**3**

(a)



(c)

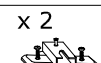

(g)



(j)

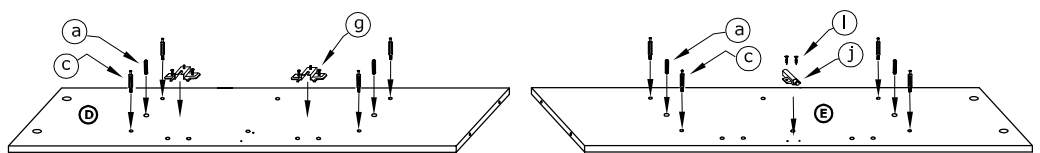

(l)

**4**

(d)

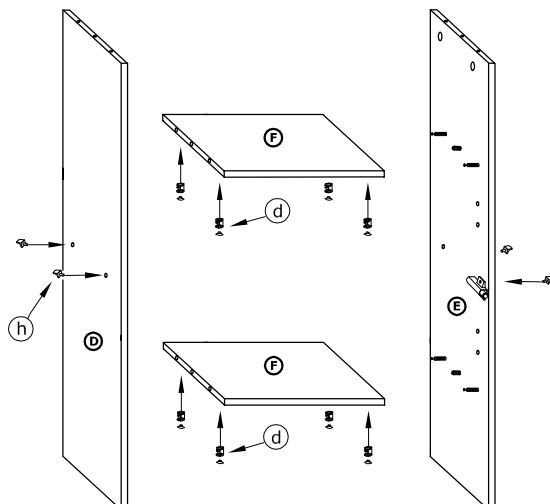

(h)

**5**

(j)



(l)

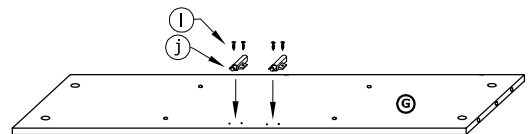

6

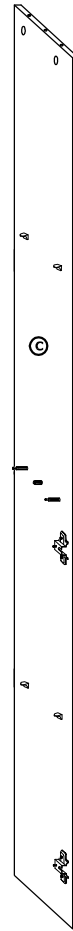
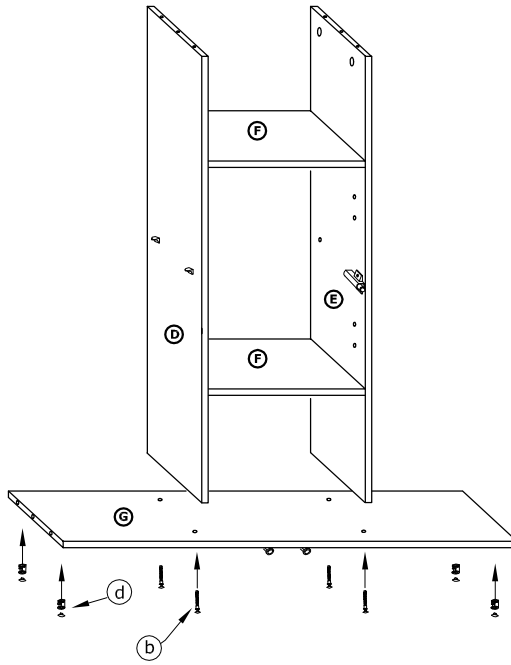
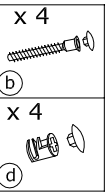

7

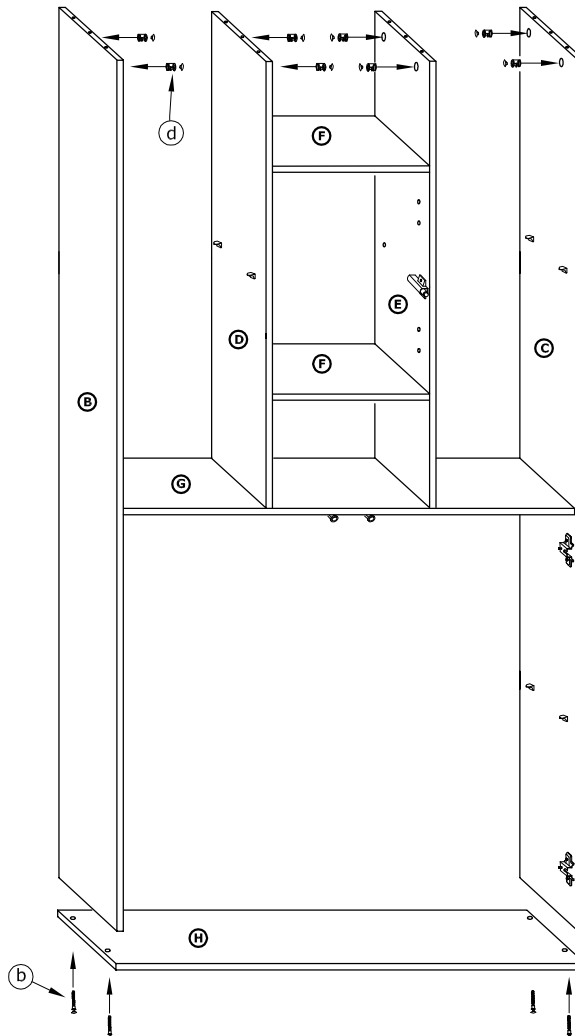
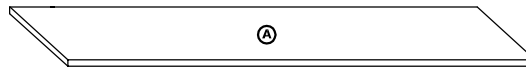
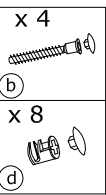

8

x 70

m

m

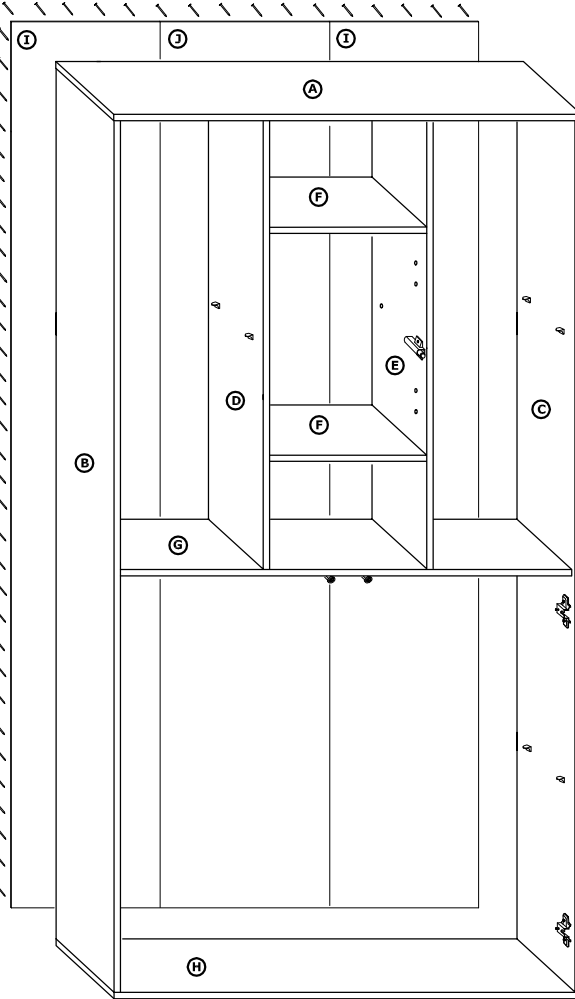

9

x 2



x 4



x 2



x 20

(3,5x16)

